

impey

impey

RETAIL WETROOM INSPIRATION BROCHURE



500,000+

Impey wetrooms installed throughout the UK and Europe.

700,000+

square metres of waterproof tanking installed.

25 YEARS+

UK's recognised market-leading wetroom manufacturer.

Our Guarantee to you

We are committed to developing and manufacturing to the highest levels of performance and design across our entire product range.

The result of our continuous improvement practices and the quality of the materials sourced across our wetroom systems allow us to offer a lifetime guarantee of performance.

For further details please refer to our website.

This is modern showering.

CONTENTS

1 THE IMPEY STORY

Manufacturing in the UK	08
The Impey brand journey	14

2 WETROOM POSSIBILITIES

Urban chic	18
Functional simplicity	24
Utilitarian magic	30
Hygge haven	34
Rustic charm	38
Luxe living	42
Minimalist beauty	46
Eclectic loft	52

3 DESIGN & INNOVATION

Aqua-Dec EasyFit™ Award-winning design	58
Aqua-Dec Linear™ Floor former innovation	60
Drainage innovation Universal and accessible components	64
The Allure Collection A choice of colours and finishes	68
Tiled Insert drain top Aqua-Dec EasyFit	70
Drain top portfolio Linear drain top designs Square drain top designs	72 73
WaterGuard™ The ultimate waterproofing solution	76

4 IMPEY INFORMATION

Wetroom layers	80
Televised transformations	88
The Coram Group	90
Contact us	91
Find your nearest Impey showroom	91

1 THE IMPEY STORY

Manufacturing in the UK 08

The Impey brand journey 14



HAND FINISHING OF AQUA-DEC EASYFIT™



The UK's market-leading wetroom manufacturer

As a UK-based manufacturer, we are proud to employ a locally-based workforce at our manufacturing site in Bridgnorth, Shropshire, and our offices in Ilton, Somerset.

At the Bridgnorth factory, we integrate a variety of streamlined, modern manufacturing processes across the Impey product range to ensure all our products are of unparalleled quality and produced as efficiently as possible.

We have invested in a wide variety of modern manufacturing processes to enable us to deliver market-leading solutions, across a wide range of technologies.

All supported with our own design, engineering and continuous improvement teams. These drive the use of new materials, in-house tooling, processes and offerings, whilst ensuring compliance through our testing facility.

APPLYING THE GEL COAT TO
THE AQUA-DEC LINEAR 4



**The SMC Aqua-Dec
EasyFit™ manufacturing
press, Shropshire**

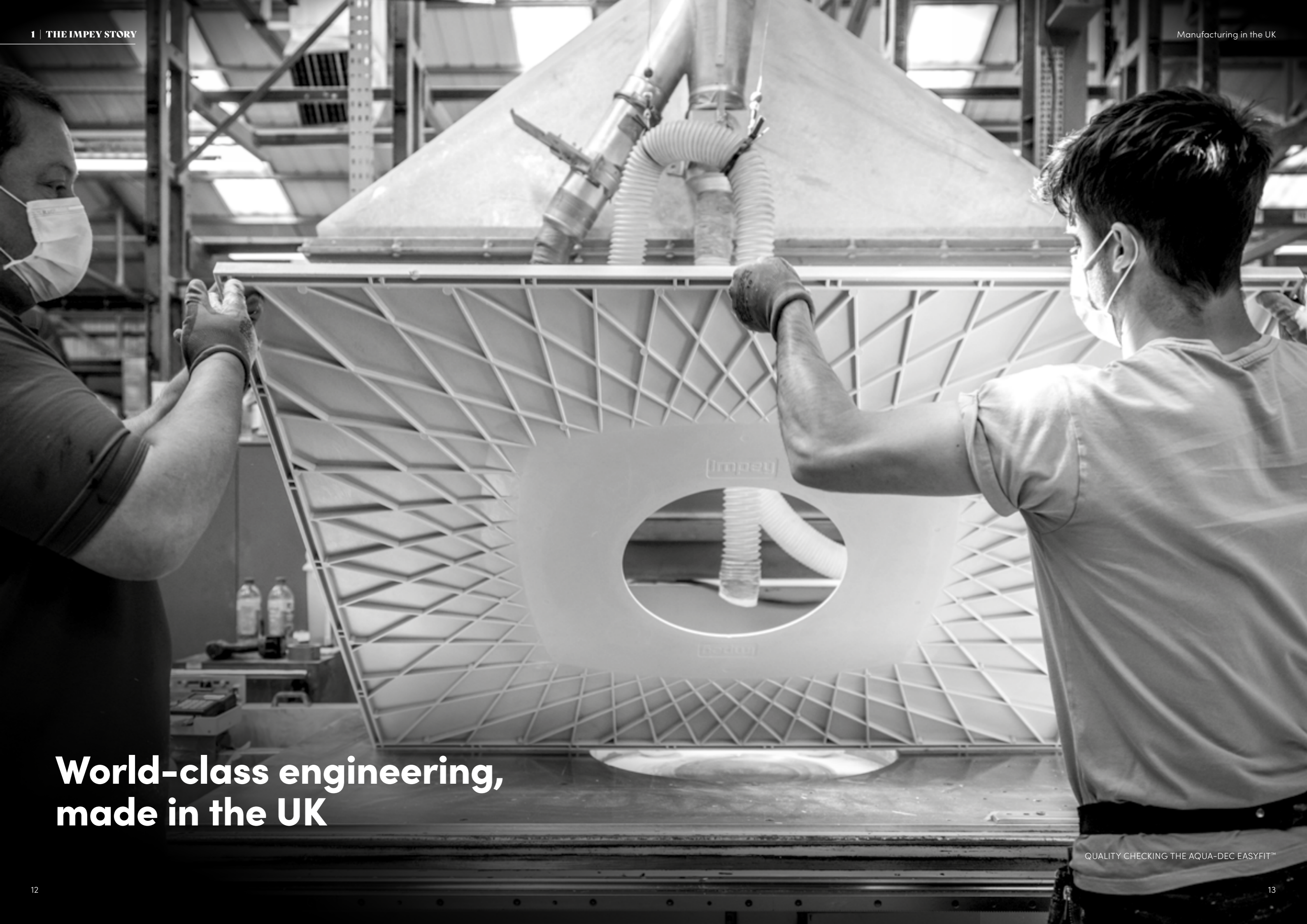

**World-class engineering,
made in the UK**

QUALITY CHECKING THE AQUA-DEC EASYFIT™

A BRAND BORN OF INNOVATION

Firmly established as the market-leader in the wetroom sector, Impey continues to lead the field when it comes to wetroom design, drainage technology and waterproofing.

1995

Founded by Bruce Grave - Impossibilities made possible, especially for you. 'Impey'. The original pioneers of level-access showering for vinyl floors.



Cutting the ribbon on the new HQ in Ilton, Somerset. The current UK Head Quarters.

2004

Development of the Aqua-Dec transforms the tiled-floor wetroom market.



Award Winning Innovation

A series of design and manufacturing awards follow for the Aqua-Dec. Impey becomes established as market leaders in wetroom technology.

2010

Impey becomes part of the Coram International bathroom group.

C O R A M

2012

The Aqua-Dec EasyFit is launched, featuring the patented and iconic central rotating drain plate.



2013

Impey WaterGuard™ is introduced. A class-leading tanking membrane, revolutionising the waterproofing process for tilers and bathroom installers.



2014

Development is finalised of a universal set of drainage components across both standard and linear wetroom floor formers.



2019

Innovative bespoke linear drain design wins the bathroom category at the 'Architects Journal' Specification Awards.



The Aqua-Dec EasyFit wins 'Best Plumbing / Drainage Product' at Build-It Awards

2020

A new range of designer linear grates are introduced. Major milestones are reached and Impey is shortlisted as the UK's 'Best Shower Brand' in the 2020 BKU Awards.



Development with Virtual Worlds to introduce a fully immersive Virtual Reality wetroom experience.

2022

Additions to drain top portfolio - Allure collection in Brushed and Polished finishes, Square Tiled Insert and Paragon drain tops.



2 WETROOM POSSIBILITIES

Urban chic	18
Functional simplicity	24
Utilitarian magic	30
Hygge haven	34
Rustic charm	38
Luxe living	42
Minimalist beauty	46
Eclectic loft	52



URBAN CHIC

Open plan showering embraces minimalist design schemes and creates a feeling of space.



Alternative drain tops are available, please see pages 68-69 to see the full range.

SOHO® WALK-IN 1000mm | AQUA-DEC LINEAR 4 1000 x 1000mm | BLACK METALLIC GLASS DRAIN TOP | GEESA NEMOX BLACK ACCESSORIES



SOHO® WALK-IN 1000mm | STRAIGHT BRACING BAR



BLACK METALLIC GLASS DRAIN TOP

Clean, contemporary lines are enhanced by the Aqua-Dec Linear floor former. Coordinating drainage options are available in glass, steel or tiled to match your design scheme.

Enhance the modern look and feel of your wetroom with a contemporary black-framed panel from our Soho range; the perfect on-trend addition to an urban, industrial inspired, wetroom.

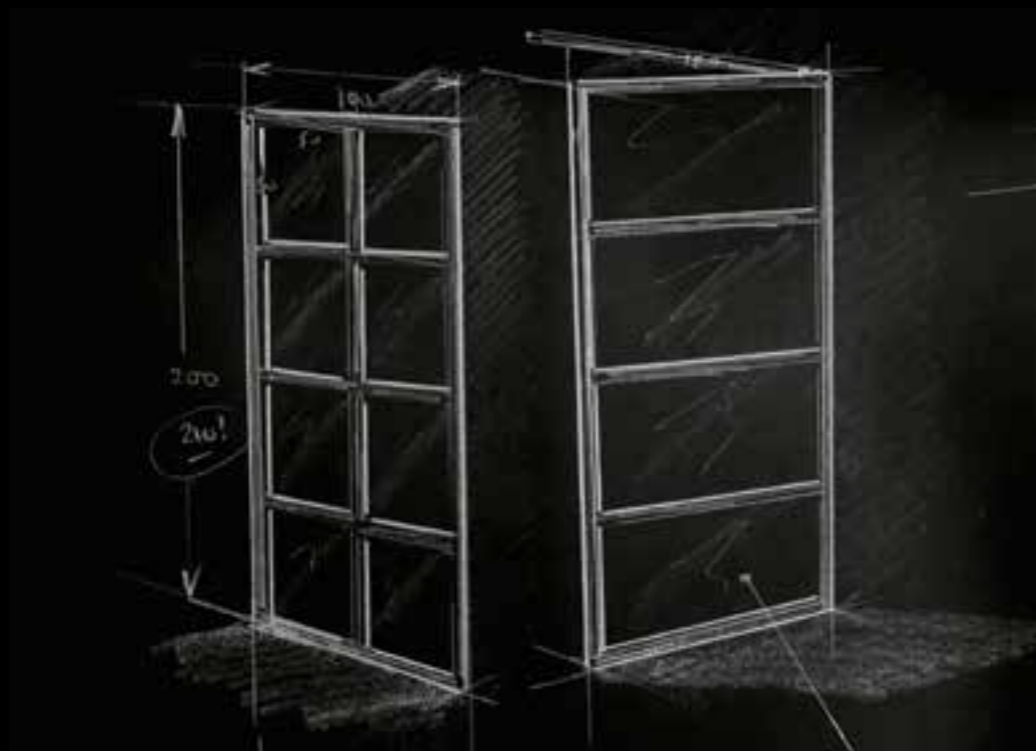

FUNCTIONAL SIMPLICITY

Modern and uncluttered, opt for an accessible showering space with natural detailing to create a light and airy showering environment.



Alternative drain tops are available, please see pages 68-69 to see the full range.

SEALSKIN DUKA PURA 5000 ENCLOSURE | AQUA-DEC LINEAR 4 1000 x 1000mm
MIRAGE DRAIN TOP | GEESA COMFORT & SAFETY ACCESSORIES



AQUA-DEC LINEAR 4 1000 x 1000mm | MIRAGE DRAIN TOP

With an eye for detail; functional features from hinges to drainage apertures, become elegant design highlights.





Offering improved accessibility, a level-access wetroom removes trip hazards and can easily incorporate stylish fixtures such as grab rails and wall-mounted shower seating.



MIRAGE DRAIN TOP

UTILITARIAN MAGIC

Simple and pared back, incorporating the most progressive wetroom product range available; an Impey wetroom can be personalised to create a clean, modern space.



Alternative drain tops are available, please see pages 68–69 to see the full range.

AQUA-DEC LINEAR 2 1200 x 900mm | MARRAKESH DRAIN TOP
GEESA FRAME COLLECTION ACCESSORIES | GEESA AIM ACCESSORIES



AQUA-DEC LINEAR 2 1200 x 900mm | MARRAKESH DRAIN TOP

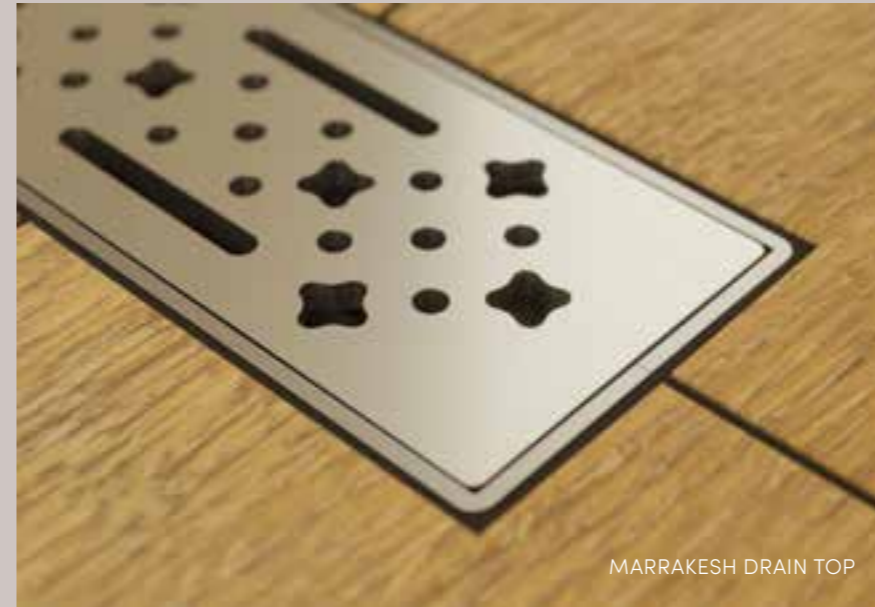

MARRAKESH DRAIN TOP

Enhance any wetroom interior by placing a contemporary drain design. Introducing a pattern into a room can add character and heighten an experience of a space.



HYGGE HAVEN

A wetroom can be integrated into any space or style of home. Blend traditional features with precision engineered wetroom technology for an elegant take on modern showering.



Alternative drain tops are available, please see pages 68-69 to see the full range.

SEALSKIN DUKA LIBERO 5000 WALK-IN | AQUA-DEC EASYFIT™ 1400 x 900mm | STAMP DRAIN TOP | GEESA WYNK ACCESSORIES



SEALSKIN DUKA LIBERO 5000 WALK-IN | AQUA-DEC EASYFIT™ 1400 x 900mm | STAMP DRAIN TOP | GEESA WYNK ACCESSORIES



STAMP DRAIN TOP



The award-winning Aqua-Dec EasyFit™ floor former incorporates four pre-formed drainage gradients with a choice of drain covers to coordinate with your style.

Combine stylish brassware and statement tiling to enhance period features in your wetroom space.



RUSTIC CHARM

Offering the ultimate in adaptability, a wet area is well suited to a boot room or utility space.

Alternative drain tops are available, please see pages 68-69 to see the full range.



SLOT DRAIN TOP



Wash off walking boots or muddy dogs! A wet space in your utility room or downstairs bathroom has many benefits. A waste pump discreetly installed, makes light work of drainage when gravity is unavailable.



LUXE LIVING

Penthouse suite to modern mansion, the durability of an Impey wetroom offers showering solutions for every size of bathroom.



Alternative drain tops are available, please see pages 68-69 to see the full range.

SEALSKIN DUKA ACQUA 5000 ENCLOSURE | AQUA-DEC LINEAR 3 1800 x 800mm
800mm BRUSHED GOLD DRAIN TOP | GEESA NEMOX GOLD ACCESSORIES

The Aqua-Dec Linear 3 offers drainage placement line with the wall, for a 'barely there' appearance.



AQUA-DEC LINEAR 3 1800 x 600mm | 800mm BRUSHED GOLD DRAIN TOP



Excellence is at the heart of the Impey brand. Each precision engineered product is designed and manufactured to last a lifetime.

MINIMALIST BEAUTY

A sleek and stylish minimalist wetroom can provide a welcome escape from the bustle of everyday life; ideal for relaxation and escapism.



Alternative drain tops are available, please see pages 68-69 to see the full range.



AQUA-DEC LINEAR 3 1200 x 900mm | ECHO DRAIN TOP



Inspired by urban industrial designs, this contemporary look transforms any wetroom space with minimal effort.



Coordinating wall-mounted accessories add to the industrial design aesthetic and offer the ideal finishing touch to your modern wetroom space.





ECLECTIC LOFT

A wetroom offers the ideal showering solution for even the most unusual spaces including loft and attic conversions.

Alternative drain tops are available, please see pages 68–69 to see the full range.



AQUA-DEC EASYFIT™ 1850 x 900mm | GRID DRAIN TOP



Make the most of the available floor area and utilise previously inaccessible spaces by converting those unused areas into the ultimate wetroom installation.

3 DESIGN & INNOVATION

Aqua-Dec EasyFit™ Award-winning design	58
Aqua-Dec Linear™ Floor former innovation	60
Drainage innovation Universal and accessible components	64
The Allure Collection A choice of colours and finishes	68
Tiled Insert drain top Aqua-Dec EasyFit	70
Drain top portfolio Linear drain top designs Square drain top designs	72 73
WaterGuard™ The ultimate waterproofing solution	76

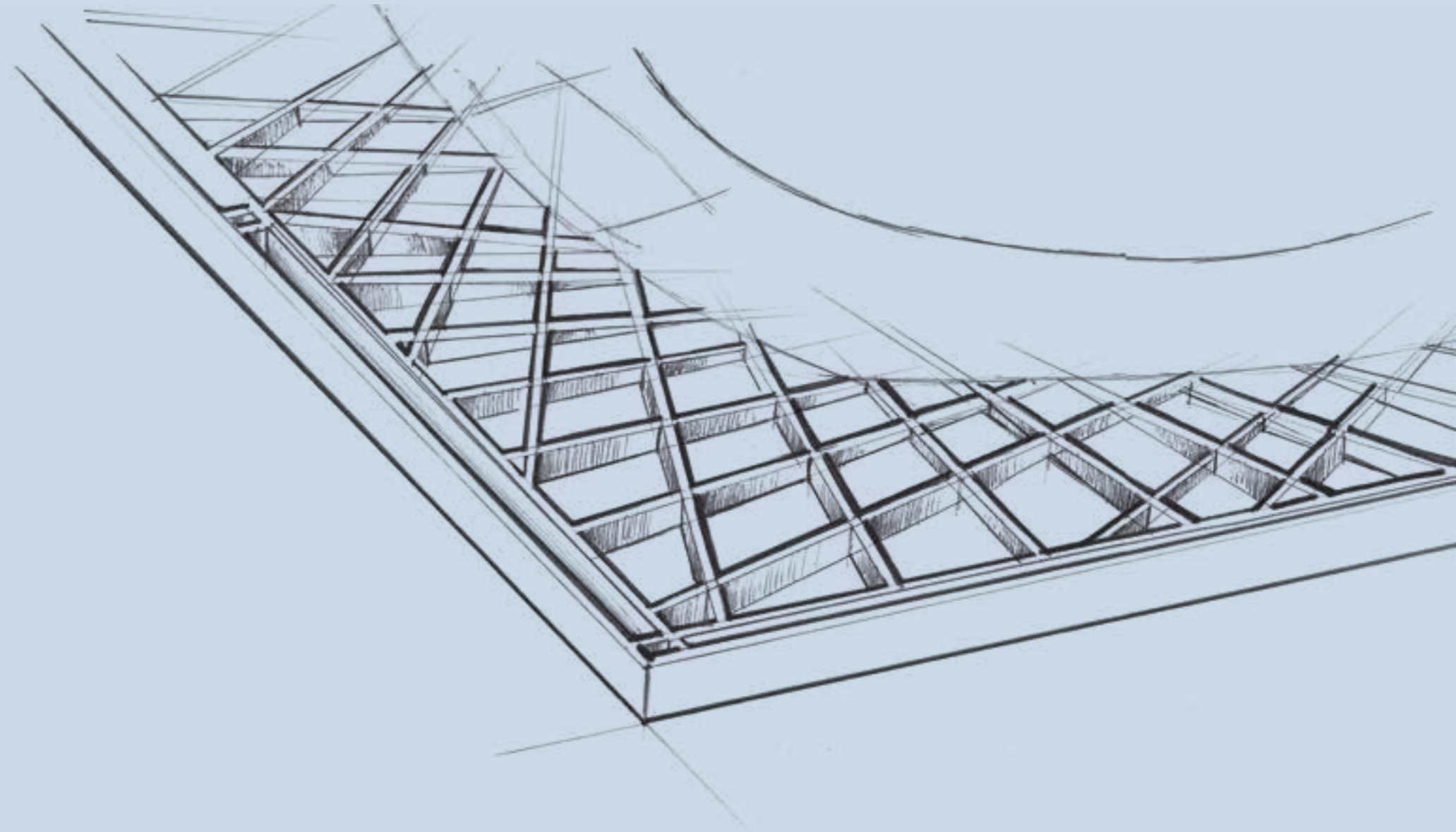

AQUA-DEC EASYFIT™ AWARD-WINNING DESIGN

Winner of the 2019 Build-It Awards, the Aqua-Dec EasyFit features a large central 360° rotating drain plate to help circumnavigate all potential floor joists and underfloor obstructions.

The Aqua-Dec EasyFit floor former is an extremely strong 22mm thick SMC floorboard replacement with four pre-formed drainage gradients to provide a level-access wetroom floor suitable for tiling. Patented innovation that delivers unrivalled installation benefits.

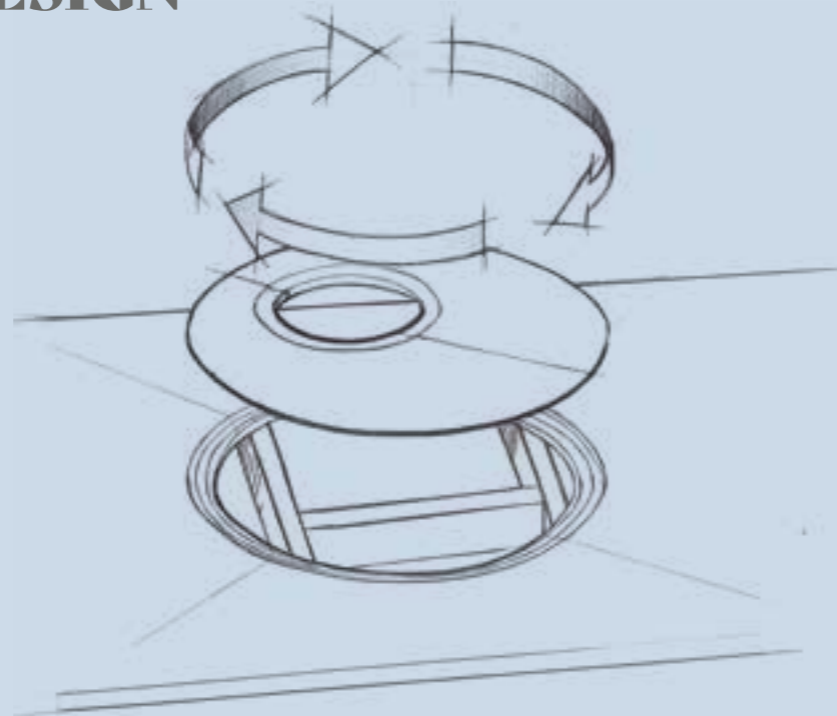

This floor former can be used with a variety of drain types to suit all applications, and a range of Drain Tops to add individual style to every wetroom. The Aqua-Dec EasyFit can be installed on timber or concrete floors, providing flow rates of up to 36l/min (depending on drain top).



Lifetime Watertight Guarantee
Install our WaterGuard™ system with any Aqua-Dec floor former and receive our Lifetime Watertight Guarantee.

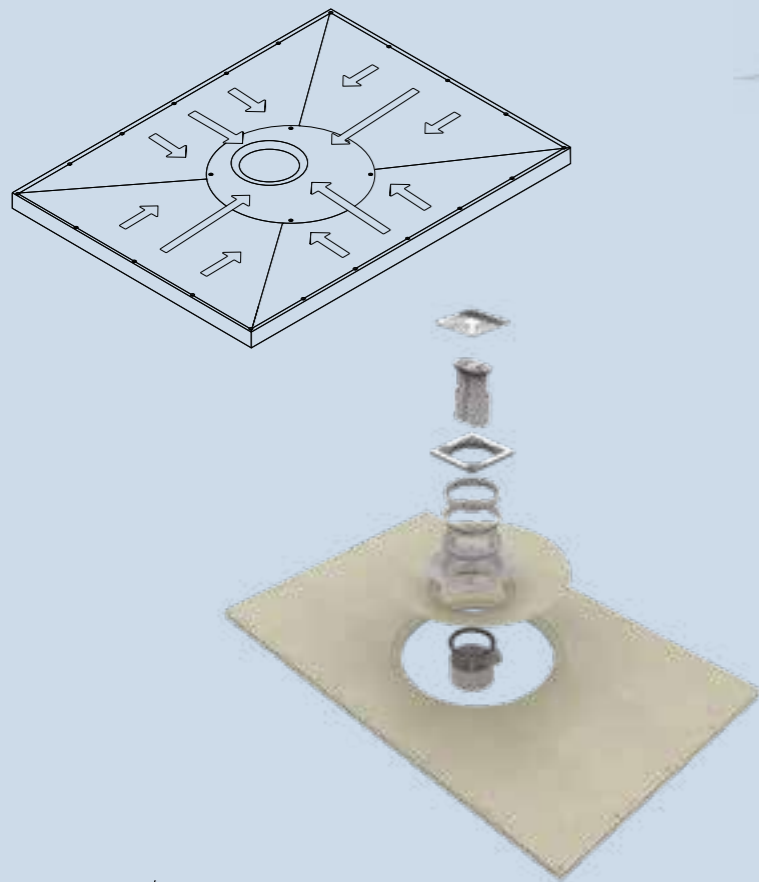

The Aqua-Dec EasyFit floor former can be trimmed anywhere up to the solid surround with a standard handsaw and features an underside cellular structure. The underside spoke pattern also provides increased rigidity to the structure of the floor former.

Aqua-Dec EasyFit is available in a range of sizes from a compact 800mm square to the most spacious 1850 x 900mm option.

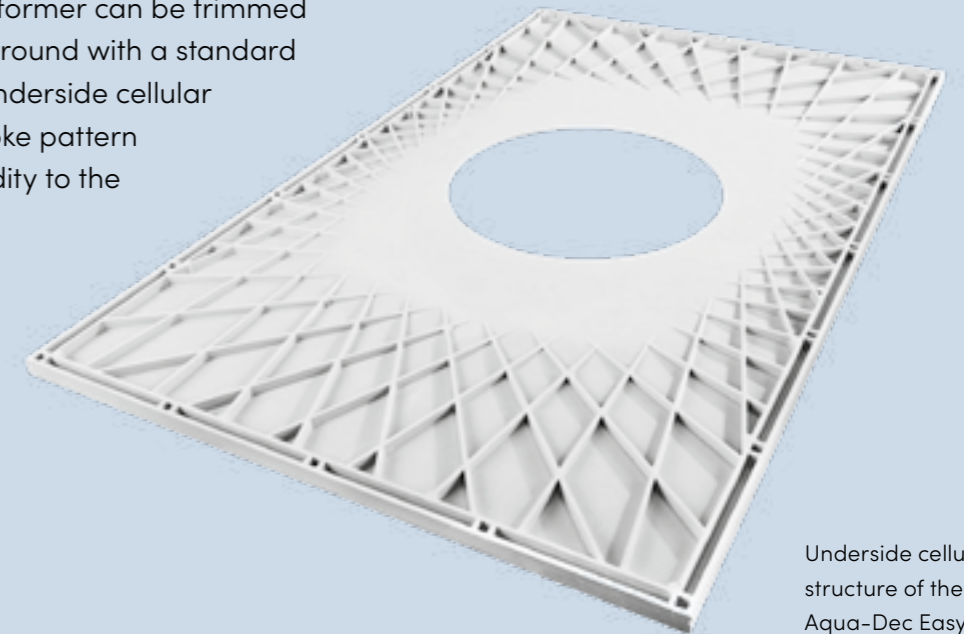

Underside cellular structure of the Aqua-Dec EasyFit



Suitable for both wooden and concrete floor installation. The Aqua-Dec EasyFit can be fitted on either floor type as the floor former is the same depth as most floorboards and the spoke structure provides the perfect surface to bond with wet concrete.



Build-It Awards 2019
Best Drainage or Plumbing Product

Aqua-Dec EasyFit and product design are trademarked. Aqua-Dec EasyFit remains the intellectual property of Impey.



The Aqua-Dec EasyFit is made in the UK

AQUA-DEC LINEAR™ FLOOR FORMER INNOVATION

Designed with choice in mind, the Aqua-Dec Linear floor former range helps to achieve the desired look of each unique wetroom, with three design variations and ranging in size from 900 x 900mm to 1800 x 900mm.

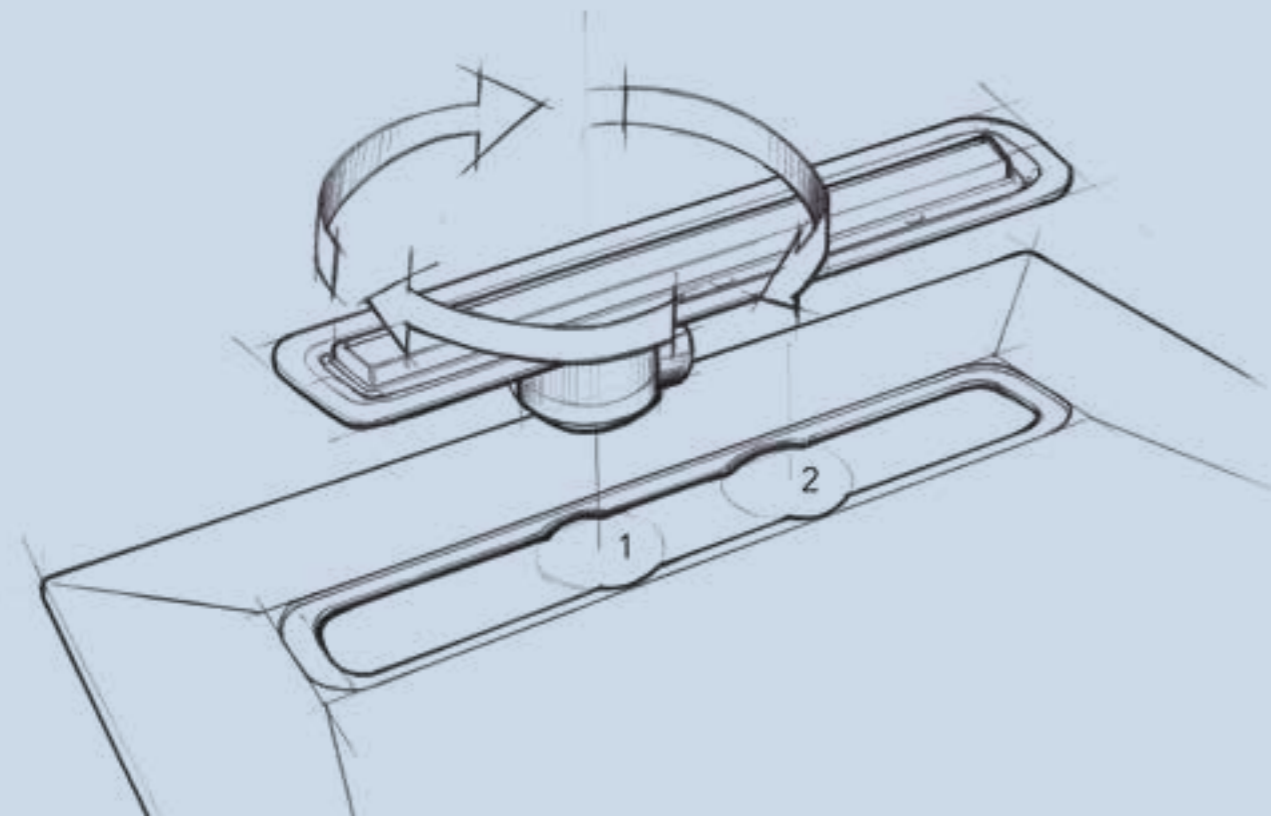

The Aqua-Dec Linear range features an elegant linear drain top in either a 600mm or 800mm length depending on the size of the floor former.

The drain outlet is offset allowing the drain to be rotated 180° at installation, the outlet is also fully rotatable allowing 360° waste positioning to avoid any potential obstacles such as joists and pipework.



The Aqua-Dec Linear 2, 3 and 4 are made in the UK



Lifetime Watertight Guarantee

Install our WaterGuard™ system with any Aqua-Dec floor former and receive our Lifetime Watertight Guarantee.

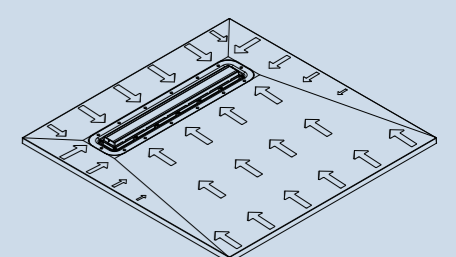
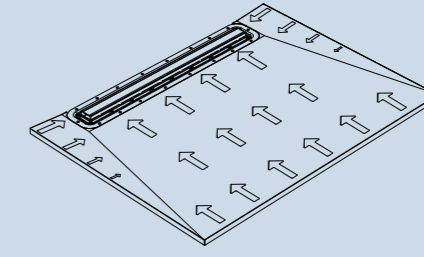
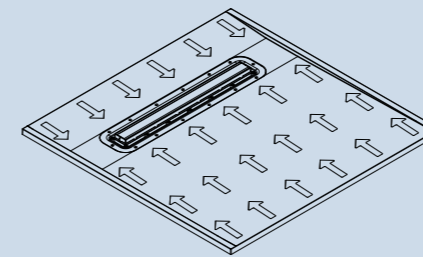

Aqua-Dec Linear 2

The construction of the Aqua-Dec Linear 2 wetroom floor former means there is no need to mitre the tiles in the corners. High-quality stainless steel inserts are supplied to finish the tile edges, which can be either flush to a wall or covered with a wetroom glass panel. The Aqua-Dec Linear 2 is 22mm thick and can be installed on timber or concrete floors, providing flow rates of 35-39l/min (depending on drain top).

Aqua-Dec Linear 3

Unlike the Aqua-Dec Linear 2 and 4, the Aqua-Dec Linear 3 can be cut to length within 75mm each side of the drain edge to assist with alcove spaces. Ideal for a minimal 'barely there' look with a compatible walk-through screen. The Aqua-Dec Linear 3 is 22mm thick and can be installed on timber or concrete floors, providing flow rates of 35-39l/min (depending on drain top).

Aqua-Dec Linear 4

The style of the floor former, with 4 gradients leading down to the drain, draws your eye to the Linear Drain Top and provides a real statement. The broad range of sizes, 2 drainage widths of 600mm and 800mm and balanced design makes this the most versatile Linear floor former. The Aqua-Dec Linear 4 is 22mm thick and can be installed on timber or concrete floors, providing flow rates of 35-39l/min (depending on drain top).

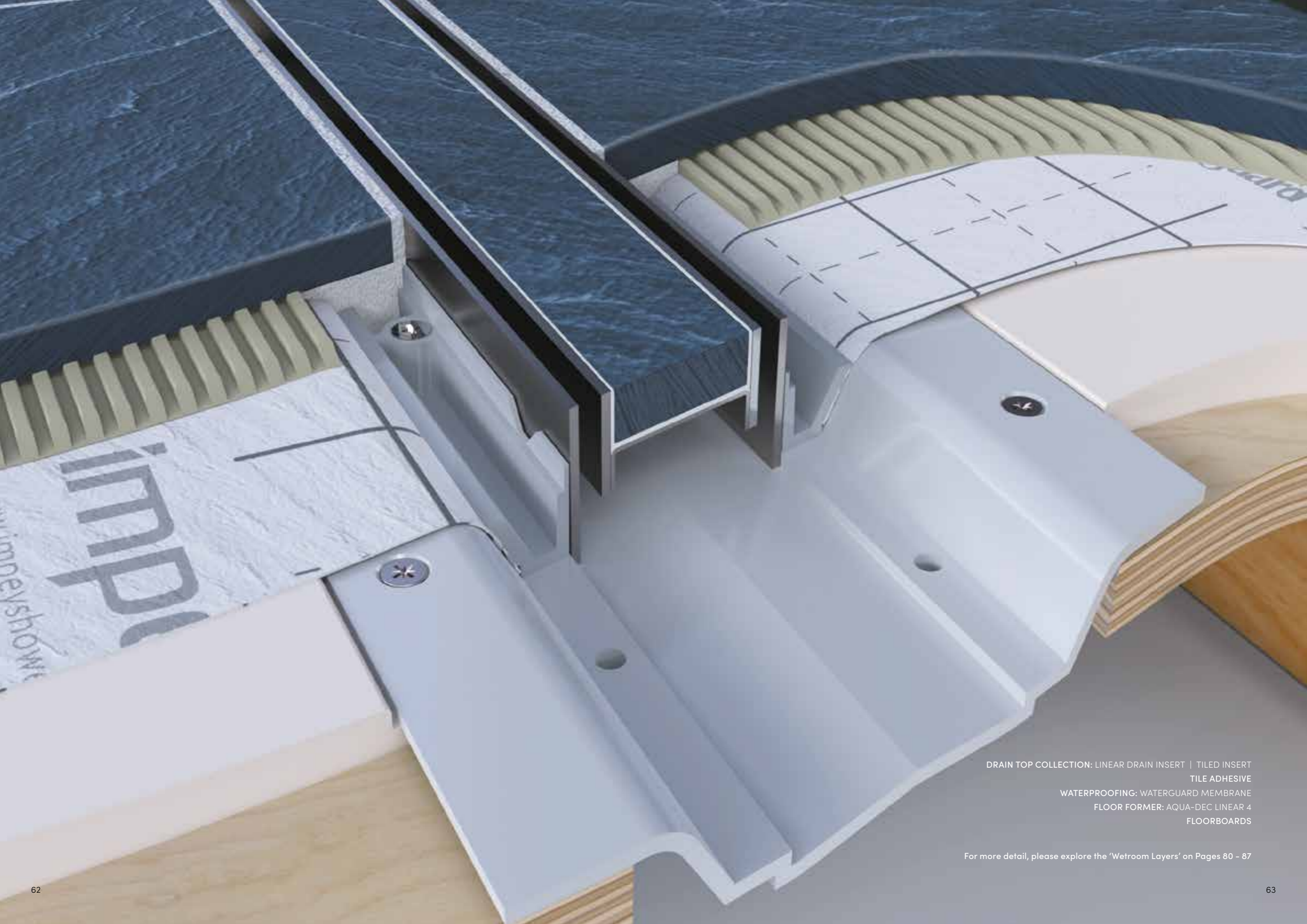

DRAIN TOP COLLECTION: LINEAR DRAIN INSERT | TILED INSERT
TILE ADHESIVE
WATERPROOFING: WATERGUARD MEMBRANE
FLOOR FORMER: AQUA-DEC LINEAR 4
FLOORBOARDS

For more detail, please explore the 'Wetroom Layers' on Pages 80 - 87

DRAINAGE INNOVATION UNIVERSAL AND ACCESSIBLE COMPONENTS

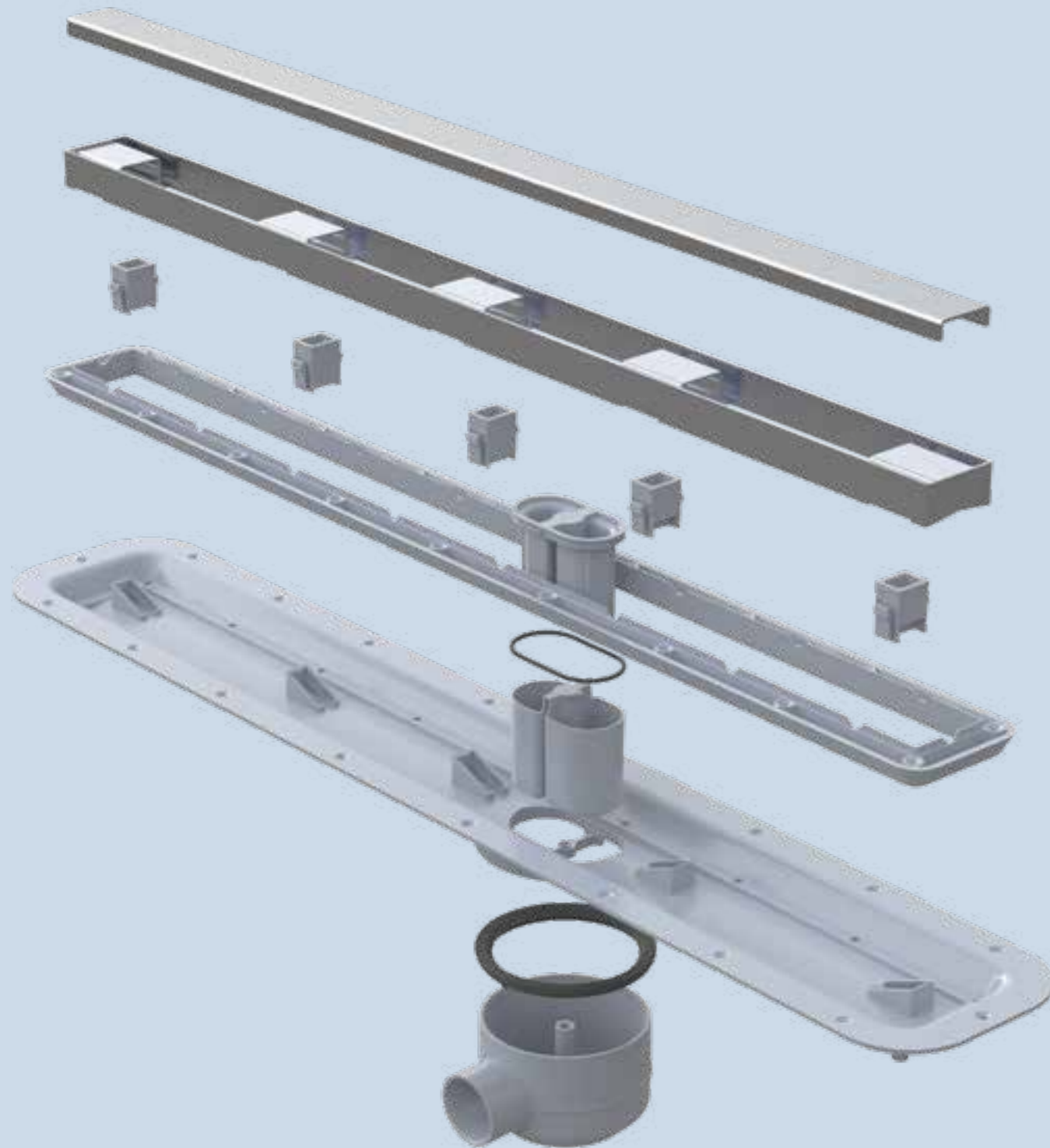

Investment and continual innovation by the in-house design teams over the last two decades has resulted in a range of high performance and aesthetically pleasing drainage systems with universal components that can be easily accessed for cleaning and maintenance.

All Aqua-Dec floor formers feature an advanced water-sealed overlay to omit any escaping drainage odours and are supplied with a unique easy-cleaning tool to remove any trapped hair, negating the need to clean with harsh chemicals.

The inbuilt membrane clamping ring secures the WaterGuard™ membrane into place creating a secure watertight seal at the drainage point.

Benefits of the universal drain

1. Adjustable tiling edges - All Aqua-Dec floor formers feature up to 20mm of adjustment for different tile heights (depending on chosen drain top).
2. Shallow depth - requires less space under the floor.
3. Soil pipe connection - can be connected directly to a 110mm soil pipe socket with no extra parts needed.
4. Patented Impey design - allows for retro fitting and aesthetic upgrades.
5. 2-Part drain - can be fully water tested before floor former is secured down.





FLOOR FORMER: AQUA-DEC LINEAR 4
DRAIN TOP COLLECTION: LINEAR ALLURE | POLISHED ANTHRACITE

THE ALLURE COLLECTION

A CHOICE OF COLOURS AND FINISHES

The Allure collection, launched in September 2022, provide a choice of colour, all available in either a brushed or polished finish. All drain tops have been designed to enhance finishes, accents and accessories within the bathroom environment allowing you to truly personalise your wetroom with colour.

The PVD-coated drain tops across the Allure collection are available in four new colours; gold, black, bronze and anthracite, with a choice of brushed or polished finish.

Colour finishes are available in three different sizes; 600mm linear, 800mm linear and 111mm².

600mm and 800mm linear drain tops are installed with the Aqua-Dec Linear floor former range.

All available colours and finishes are available as a square drain top with the Aqua-Dec EasyFit floor former.

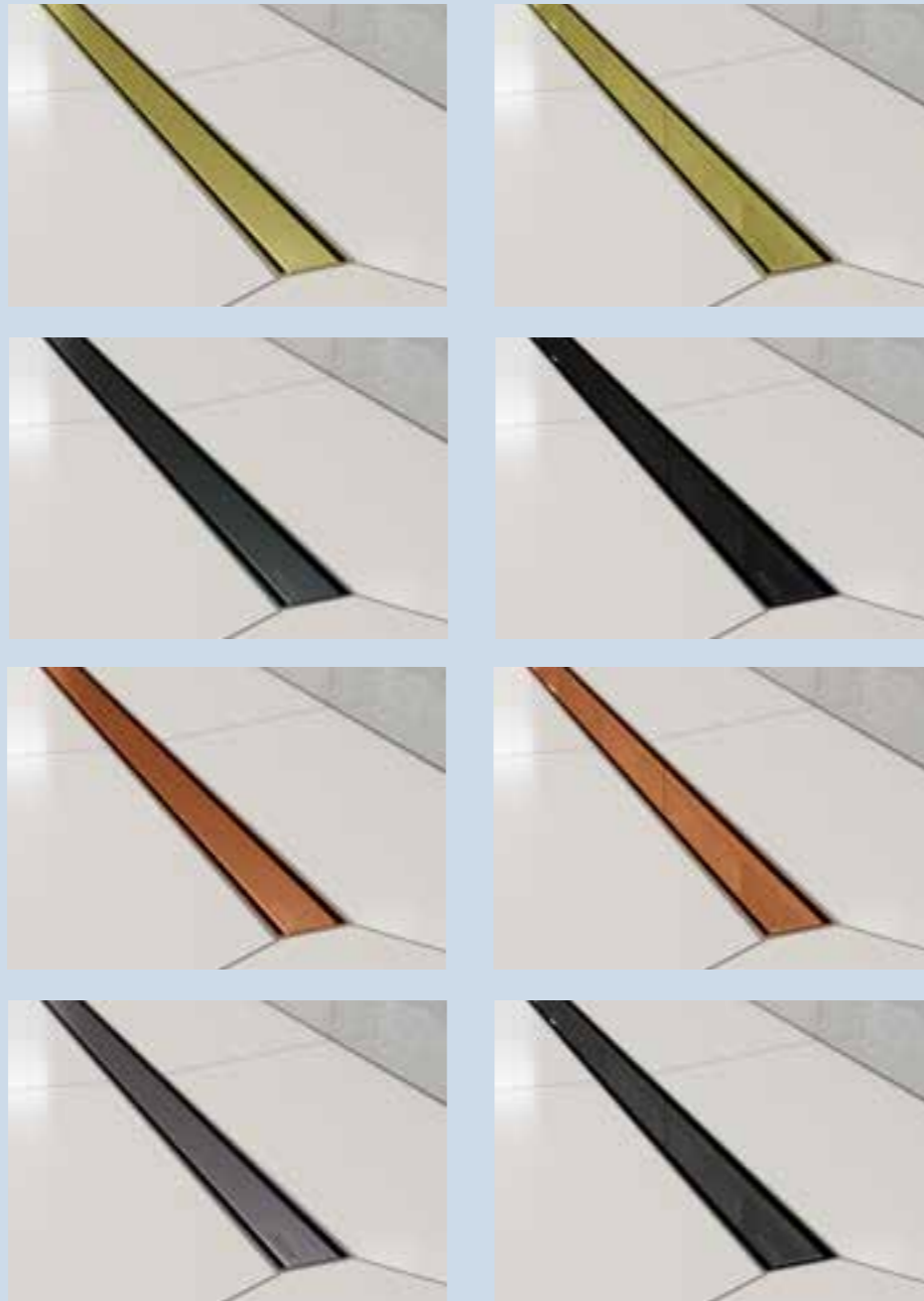

Brushed finish
600mm or 800mm drain top
Aqua-Dec Linear 2, 3 and 4
Height adjustment of 6 - 26mm

Polished finish
600mm or 800mm drain top
Aqua-Dec Linear 2, 3 and 4
Fixed height at 13mm

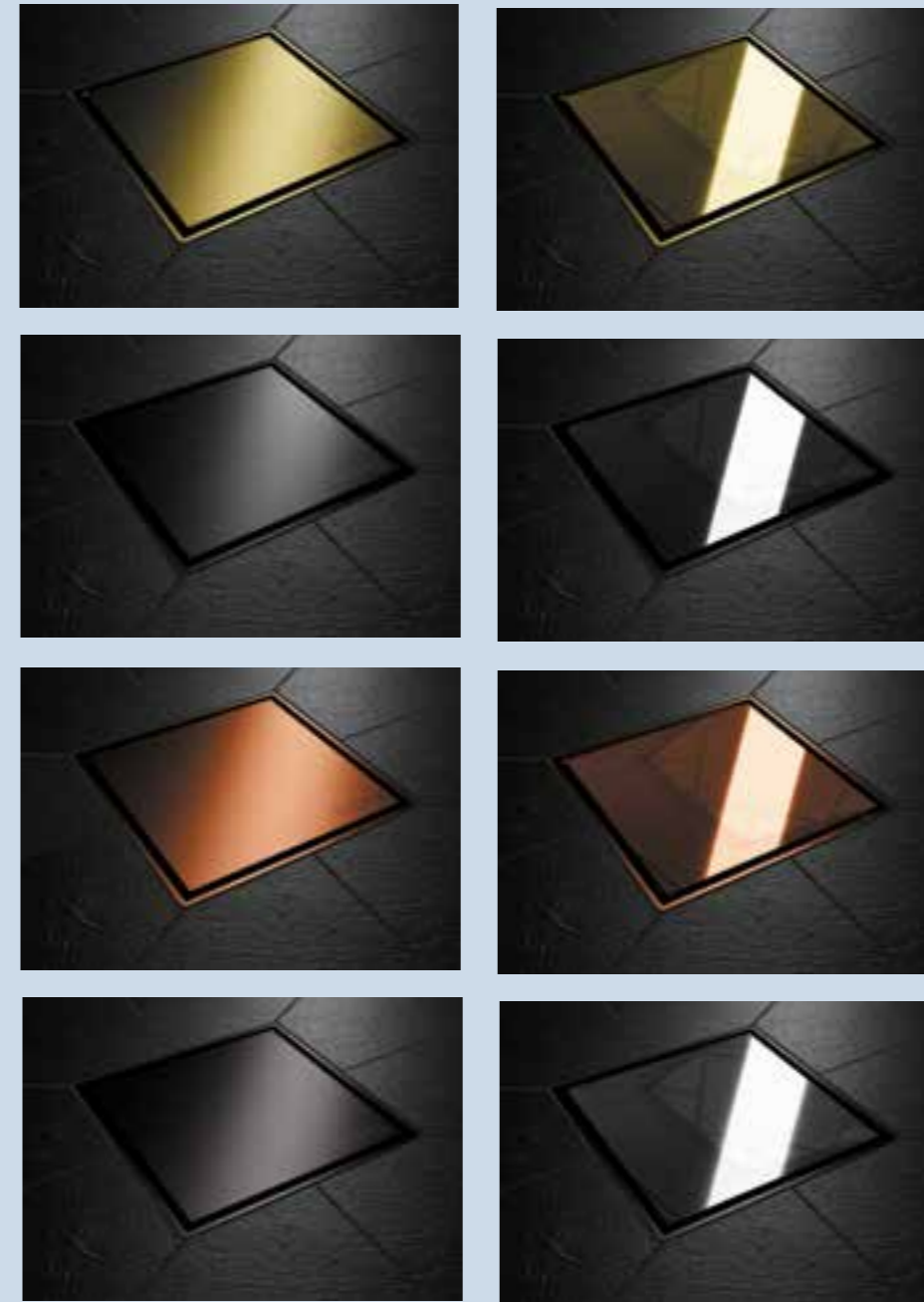

Brushed finish
111mm x 111mm drain top
Aqua-Dec EasyFit
Height adjustment of 14 - 24mm

Polished finish
111mm x 111mm drain top
Aqua-Dec EasyFit
Height adjustment of 14 - 24mm

All drain tops in the Allure collection are manufactured in the UK using locally sourced products and suppliers. Targeting sustainability with making most packaging with recyclable cardboard and the products are PVD coated; the most energy efficient coating process.

Delivering high flow rates, exceptional quality and manufactured with a low carbon footprint.

 All Drain Tops are made using 304 grade stainless steel in the UK

TILED INSERT DRAIN TOP FOR AQUA-DEC EASYFIT



Creating a consistent and beautiful tiled floor finish has never been easier - Designed and engineered with premium materials and manufactured in the UK, this modern drainage solution boasts style, elegance and market-leading innovation throughout.

The new tiled insert drain is loaded with technical features for easy installation and adjustment. This drain performs to our very highest performance expectations and seamlessly integrates into the wider Impey wetroom system.

A system that includes the UK's most popular wetroom floor former with over half a million installations, the Aqua-Dec EasyFit and WaterGuard, the most advanced solution to wetroom waterproofing, guaranteed for life.

The wide range of sizes, drainage options and styles provide the opportunity to design and create a wetroom to your specification and needs.



**All Drain Tops are
made using 304 grade
stainless steel in the UK**

DRAIN TOP PORTFOLIO

The range of designs, colours and finishes add a lustrous, high-end designer style to any bathroom. All linear and square drain tops are designed and manufactured in the UK and laser cut from the highest quality stainless steel specifically for Impey wetroom floor formers.



All Drain Tops are made using 304 grade stainless steel in the UK

LINEAR ALLURE

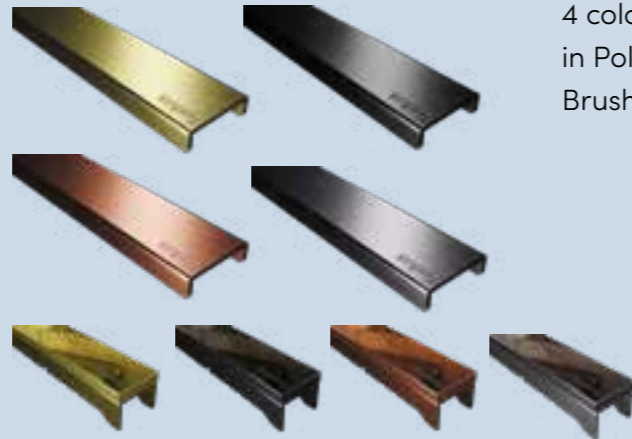
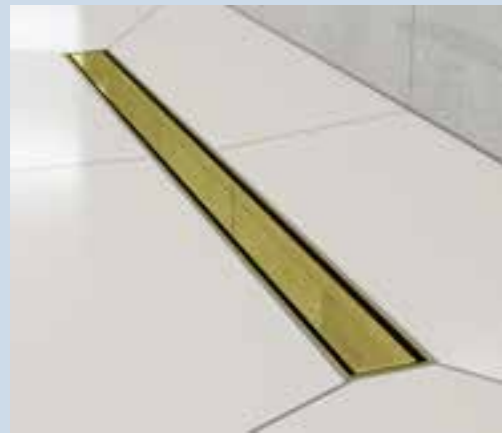

4 colours available in Polished or Brushed finish

SQUARE ALLURE

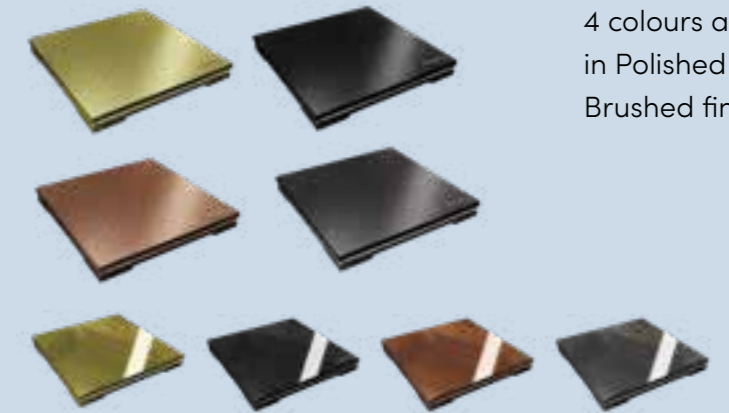
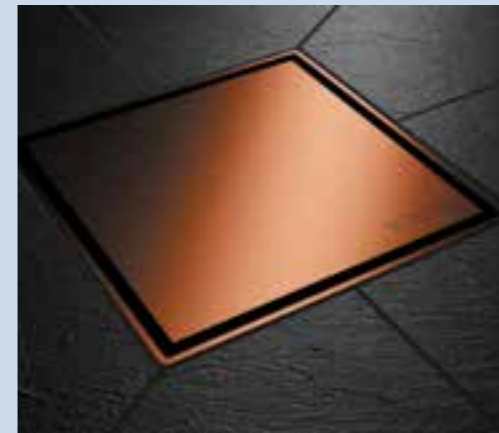

4 colours available in Polished or Brushed finish

LINEAR DRAIN INSERT

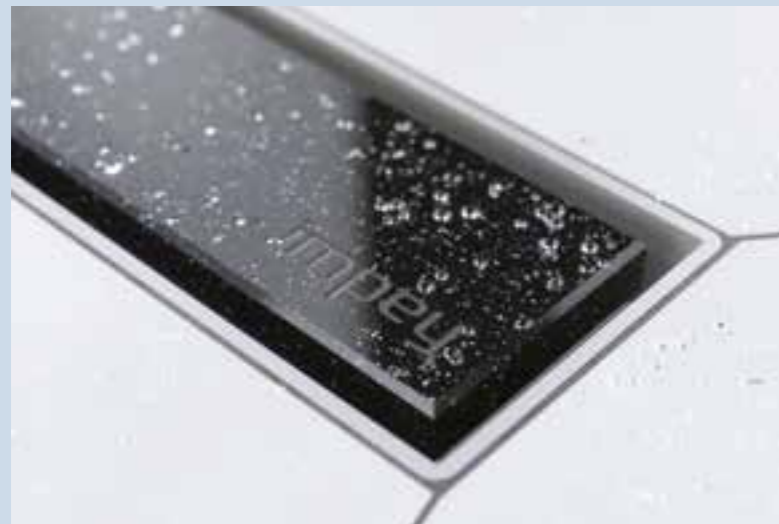

Options of Black Metallic Glass, Mirage and Tiled Insert

SQUARE DRAIN INSERT

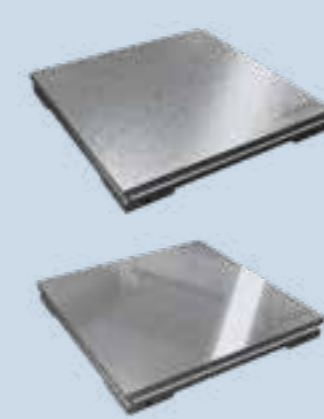

Options of Tiled Insert, Paragon Brushed and Paragon Polished

LINEAR DESIGNER

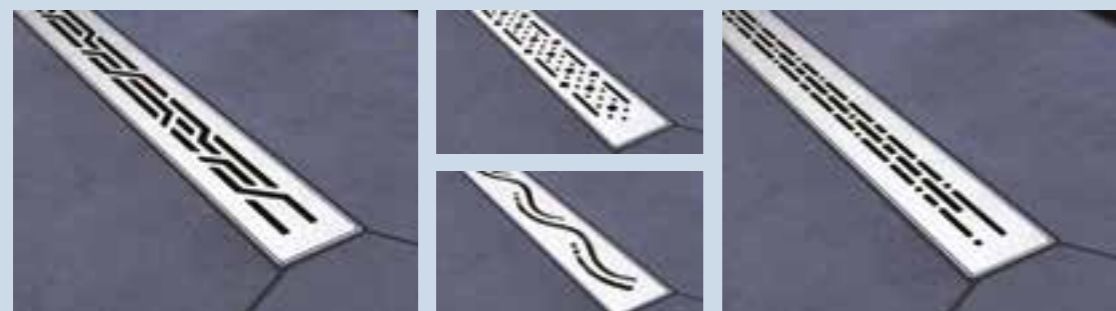

Designs include: Connect, Marrakesh, Echo, Morse

SQUARE PATTERN



Patterns include: Stamp, Slot, Grid, Identity, Fibre



impey

WATERGUARD™ THE ULTIMATE TANKING SOLUTION



Protect your property with the complete waterproofing solution, for all types of wetroom spaces. The revolutionary design of WaterGuard provides a guaranteed watertight barrier on floors and walls.

WaterGuard is a 1mm thick, flexible waterproofing membrane. The complete wetroom sealing solution - not just for floors but also to walls. When correctly installed across the entirety of a wetroom floor, it provides an impenetrable barrier against leaks, guaranteed for life.

WaterGuard requires no curing time and can be tiled directly after laying, reducing installation time dramatically compared to other paint-on alternatives.

Designed as the complete solution, WaterGuard has been created to withstand temperatures of 60°C ensuring it is compatible with underfloor heating, such as Impey Aqua-Mat™.



Lifetime Watertight Guarantee

We are committed to developing and manufacturing to the highest levels of performance and design across our entire product range.

Install our WaterGuard™ system with any Aqua-Dec floor former and receive our Lifetime Watertight Guarantee.

For details please visit our website.

4 IMPEY INFORMATION

Wetroom Layers	80
Televised Transformations	88
The Coram Group	90
Contact Us	91
Find your nearest Impey showroom	91



WETROOM LAYERS

All Impey wetroom floor formers are 22mm thick and can be placed directly onto timber joists or set into concrete floors and act as reinforced floorboard replacements.

All floor formers feature built-in gradients to channel water safely from all edges directly into the drain. With four types of floor former to choose from, including the Aqua-Dec EasyFit and the Linear range, you can achieve the perfect look and result for any situation.

Installed in line with supplied instructions, our range of wetroom formers easily support weights of 47 stone and are guaranteed for life.

PREPARING
YOUR WETROOM



WETROOM LAYERS

Wetroom waterproofing or 'tanking' is a process which is designed to prevent water and humidity from penetrating a showering area or building.

Water damage can cause serious issues to a building's structure. By correctly waterproofing wetroom floors and walls you guarantee a leak-free showering area. The self-adhesive WaterGuard membrane is laid across the entire floor and can also be used on walls.

A chemical-free and modern solution, WaterGuard is the most advanced wetroom tanking system available.

Receive Impey's Lifetime Watertight Guarantee when WaterGuard™ is installed correctly alongside an Impey wetroom floor former.



WATERGUARD
COVERAGE

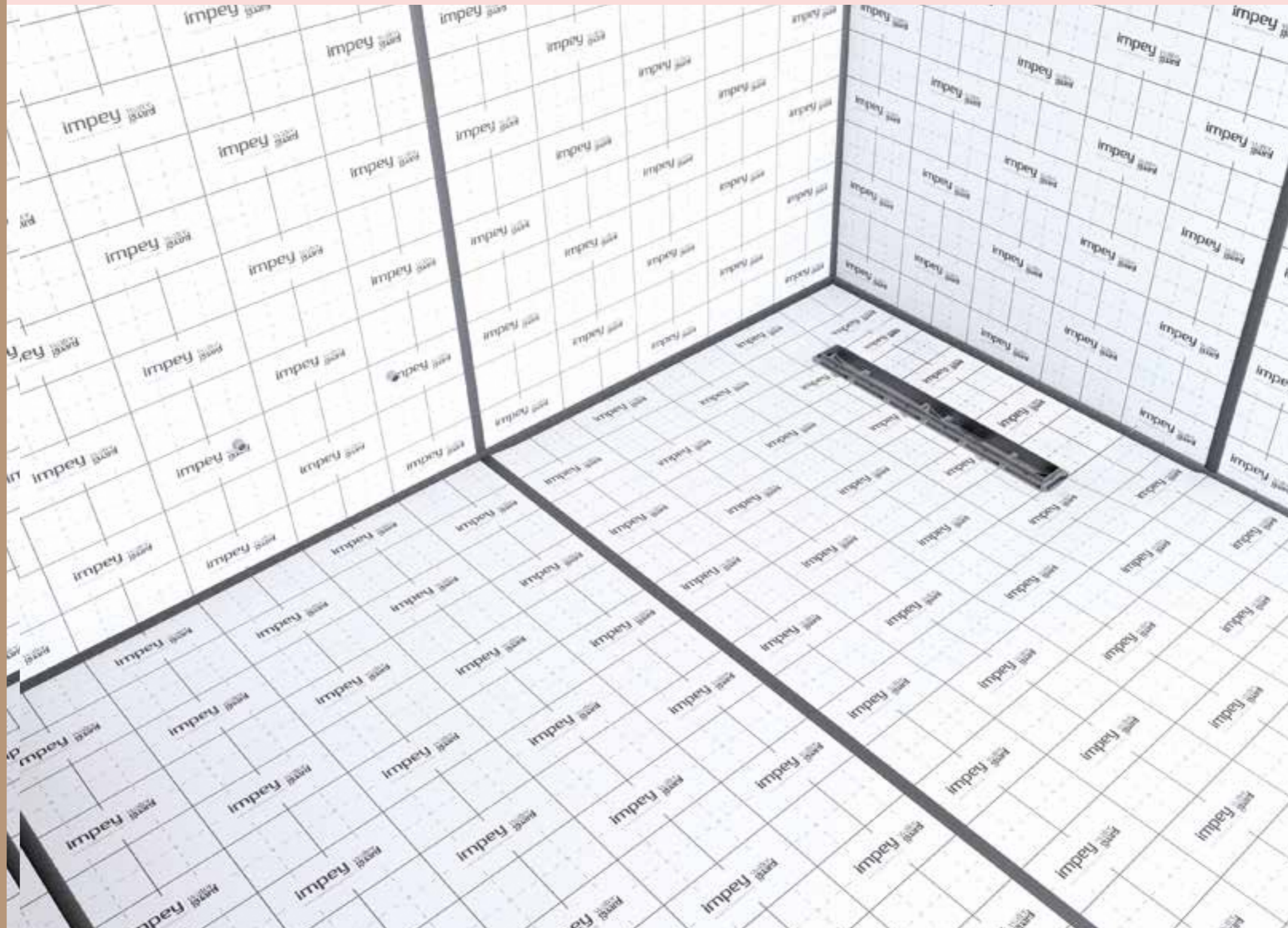

PREPARING
YOUR WETROOM



WETROOM LAYERS

Stepping into a heated and comfortable wetroom, at just the right temperature and with the floor warm to the touch, makes the showering experience even more enjoyable.

Aqua-Mat underfloor heating across the entire floor and wet area creates the ideal floor tile temperature for showering all year round and is suitable for all types of floor, new concrete or wooden.

Modern underfloor heating can now be controlled remotely to ensure you can prepare a warm floor well in advance of use.



UNDERFLOOR
HEATING

WATERGUARD
COVERAGE

PREPARING
YOUR WETROOM

WETROOM LAYERS

Tiles, wetroom screens and accessories will complete the look of your new wetroom creating a truly accessible space for all age groups. A wetroom caters for all showering needs whilst dramatically reducing cleaning times and potentially adding value to a home.

**This is an Impey wetroom.
This is modern showering.**

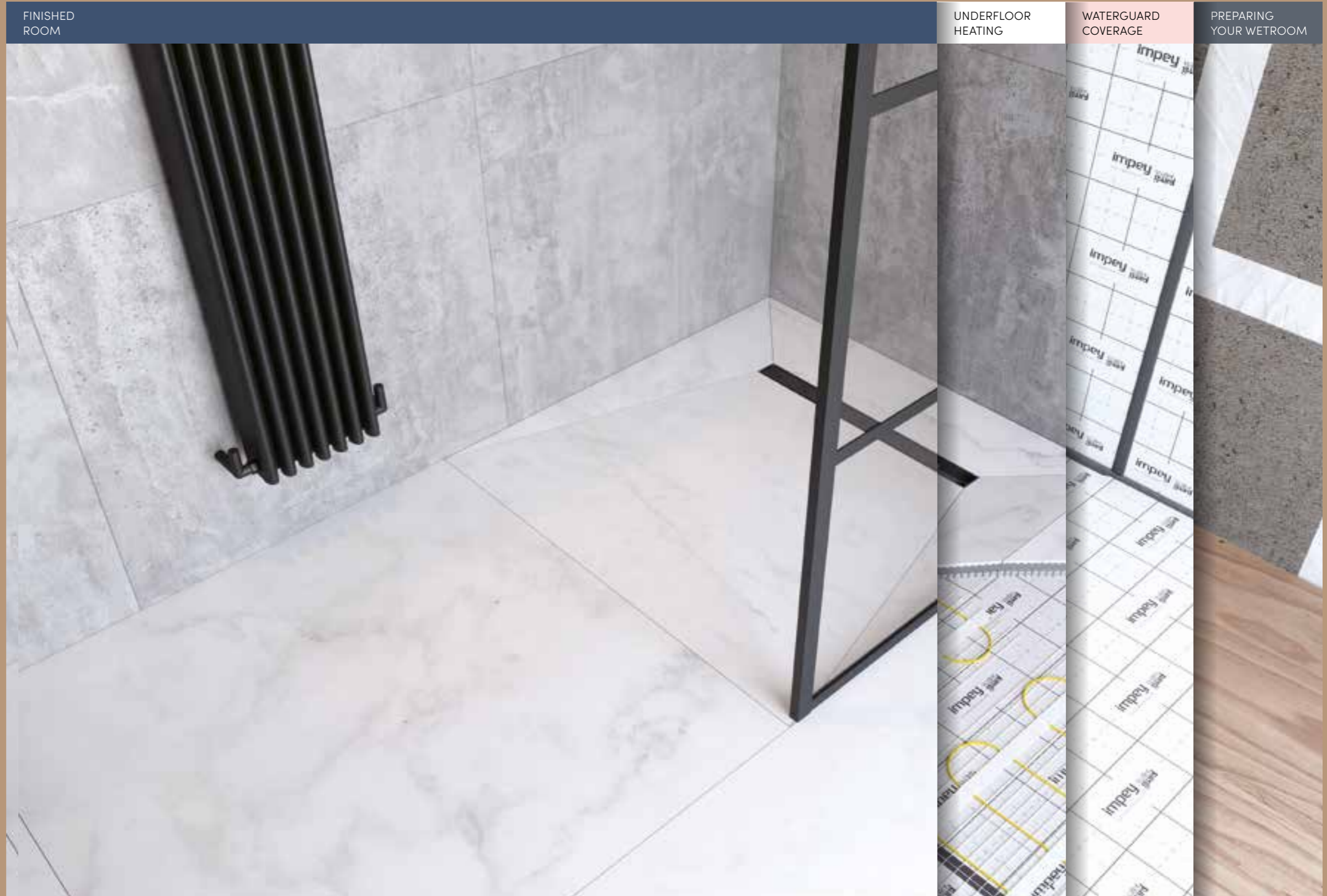

TELEVISED TRANSFORMATIONS



Showcasing some of the wetrooms featured across various home restoration TV shows.

“

I have had the pleasure of working with Impey over many years. Specifying Impey’s technically advanced yet stylish products has helped me design luxurious shower-rooms and bathrooms that not only look great but stand the test of time.

Clients and contractors have praised Impey’s products; they were particularly impressed by the quality and ease of install.

Dealing with Impey has proved a pleasant, straight-forward experience. Their technical team has been consistently helpful throughout the design process right through to the install.

Edwina Boase
Interior Designer - Stylist



None of the products, services or locations included in the programme are endorsed personally or professionally by George Clarke, Amazing Productions or Channel 4. All product selection is made by the relevant home owners based on their professional/family requirements.

For more inspiration follow @impeyshowers



THE CORAM GROUP

CORAM The Coram International bathroom group

A Dutch family owned business with over 500 employees. Offices in the Netherlands, Belgium, United Kingdom, Poland & Norway. Exporting to more than 70 countries worldwide.

OTHER CORAM GROUP BRANDS INCLUDE:



Coram Showers: A leading brand of shower enclosures, bath screens and shower trays with over 70 years of operation in the UK with very strong presence in plumbers merchant and bathroom retail sectors. Coram enclosures are designed to meet the highest aesthetic and functional standards expected whilst maintaining the reputation as a stylish and hassle-free range to install and maintain. Style with Standards.



Geesa: A world-class bathroom accessory brand since 1885. Geesa products have been installed in over 1100 hotels and cruise ships worldwide and hotel chains such as the Holiday Inn, Intercontinental and Radisson Blu. Ships such as 'Oasis of the Seas' and the 'Celebrity Solstice', each with 4000 cabins on board and thus the largest cruise ships in the world, have been furnished entirely with Geesa accessories.



Sealskin: Founded by Gerrit van Loon over 250 years ago. Sealskin started as an international producer of leather products. Over time, the company expanded its product range to include shower curtains, intended to dress the bathroom. Since 1950, shower enclosures have been added to the range, which are market-leading for their thoughtful design, smart functionality and eye for detail.

The company has been part of the Coram group since 1986 and dominates the showering market across the Benelux region.



Tiger: Founded in 1950, Tiger specialised in a manufacturing a wide range of plastic products for different applications. From bicycle handles to soap dishes. Tiger quickly became very successful in the Netherlands and in 1957 a start was made on exploring the international market. The Tiger brand grew quickly into international playing field with a wide range of bathroom accessories. The brand is recognised for it's design and innovation.

CONTACT US



Impey

Conquest House, Cad Road, Ilton, Somerset TA19 9EA

We have a dedicated Customer Services and Technical team who are on hand to offer a personalised solution to any queries regarding the Impey product range or installations.

Our opening hours are: 8:30am to 5pm Monday - Friday

Tel: 01460 256080

General enquiries or sales: salesorders@impeyshowers.com

Technical Support: technical.support@impeyshowers.com

Website: www.impeyshowers.com

FIND YOUR NEAREST IMPEY SHOWROOM

Our trusted network of retailers and showrooms stretches across the UK.

We recommend contacting the showroom to confirm that an Impey wetroom display is viewable, before visiting.



01460 256080
impeyshowers.com

@impeyshowers



Printed with biodegradable laminate:
✓ protecting the environment from single use plastics
✓ reducing negative impact on the environment.

Whilst every care has been taken to ensure that the information included in this document was accurate at the time of printing, we reserve the right to change product specifications at any time without prior notice. The photographs reproduced in this document publication are within the constraints of the printing process and are not to be used for matching purposes. All photographs are used for approximate representation only and may not show the actual products on offer. Errors and Omissions Excepted.

Full terms and conditions available at www.impeyshowers.com