

MODEL:
CALSOFT

CalSoft Mini, Midi & Maxi **Metered Water Softeners** Specification



Cal Soft

The ultimate in water softening

Welcome

Congratulations on purchasing this CALMAG water softener.

By purchasing a CALMAG water softener you are receiving not only a high quality product but also peace of mind.

Treating your water supply with a water softener gives you reassurance that your family will have access to soft water throughout your entire home.

This is a process which is simple in its concept and effective in its abilities to soften the water supply.

Simple maintenance, and continuous soft water, CALMAG makes it that easy.

Contents

- 1. Components & Information**
- 2. Installation guidelines**
- 3. Installation diagram - pipework**
- 4. Dimensions**
- 5. Installation and start up procedure**
- 6. Programming and Bypass assembly**
- 7. Troubleshooting**
- 8. Warranty Statement**

PLEASE NOTE:

Whilst reading this manual it is strongly recommended that if you are in any doubt of the contents, please **DO NOT** carry out any of the operations on the control valve. We would recommend that a competent qualified plumbing installer is contacted to install the product.

Components

Automatic control valve:

- Noryl plastic approved by FDA.
- Strong corrosion resistance
- Innovative design
- Refined structure

Resin vessel:

- Fibreglass reinforced plastic
- Polyethylene material manufactured for the food and beverage industries
- Light
- High pressure resistance
- Strong corrosion resistance

Resin:

- High grade anion exchange resin
- Food grade used in the food and beverage industries

Brine valve:

- Safe and reliable structure
- High pressure resistance

CalSoft Mini, Midi & Maxi

1. Components & Information

| Information | CALSOFT MINI | CALSOFT MIDI | CALSOFT MAXI |
|--|--------------------|--------------------|--------------------|
| Fits under a sink | YES | NO | NO |
| Parts guarantee | 5yr | 5yr | 5yr |
| Metered | YES | YES | YES |
| No of people | 1-8 | 1-11 | 1-15 |
| Capacity per regeneration @300ppm | 2000 litres | 3000 litres | 4000 litres |
| All domestic situations | YES | YES | YES |
| Salt used per regen (approx) | 2kg | 2.8kg | 3.5kg |
| Water used per regen (approx) | 85 litres | 115 litres | 202 litres |
| Preferred salt used | Tablet | Tablet | Tablet |
| Installation kit included | YES | YES | YES |
| Water hardness test kit included | YES | YES | YES |
| Extended warranty available | YES | YES | YES |
| Max flow rate l/min with 15mm kit | 50 | 50 | 50 |
| Max flow rate l/min with 22mm kit | 70 | 70 | 70 |
| Max pressure recommended | 5 bar | 5 bar | 5 bar |
| Salt storage capacity | 15kg | 25kg | 35kg |
| Inlet/Outlet | 3/4" BSP or 1" BSP | 3/4" BSP or 1" BSP | 3/4" BSP or 1" BSP |

CalSoft Mini, Midi & Maxi

2. Installation guidelines

Valve Display

Your CalSoft unit has been pre-programmed for a water hardness level of 300ppm. Under normal operating conditions these settings do not require any adjustment but if they are required to be adjusted please contact your installer or Calmag.

If the electricity fails, the electronic controller will keep in the memory the pre-set program. Use the up and down arrows to set the correct time of day.

If you need to manually initiate a regeneration, please see section “PROGRAMMING” in the manual.

Operating Tips

- Keep the bypass closed at all times. Open the bypass to service the water softener and to allow hard water to service.
- Keep the salt level at all times above the water in the brine tank.

Installation

Water pressure

A minimum of 1.5 bar inlet water pressure is required for the valve to operate effectively. Do not exceed 5 bar. If the pressure is higher fit a pressure reducing valve. **Note:** It is recommended that a pressure reducing valve rated at 5 bar should be fitted on the valve inlet.

Electrical connection

A standard UK power supply is required to operate the unit.

Bypass

Always provide a bypass valve for the installation.

Water temperature

Water temperature is not to exceed 43°C. The unit cannot be subjected to freezing conditions. Both will invalidate any guarantees.

EXAMPLE

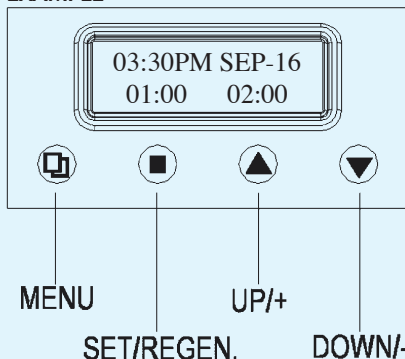

CalSoft Mini, Midi & Maxi

2. Installation guidelines

Manual Regeneration

Press and hold the key '□' for 3 seconds to unlock keys.

In stand-by position, you can press and hold the key '■' for 5 seconds whereby the valve will go into the manual regeneration interface:



(1) If you choose 'DELAY' and press key '□' to exit, the valve will regenerate in the next REGEN. TIME (default is 2am).

Note: The regeneration mode "METER IMMEDIATE" has no 'DELAY' choice.

(2) If you choose 'IMMEDIATE' and press key '□' to exit, the valve will regenerate immediately.

When regeneration has started, the screen will display:



"BACKWASHING" starts flashing. When the valve reaches "BACKWASH" position, "BACKWASHING" will stop flashing. Vertical bars will decrease on the regeneration cycle. Pressing any key will automatically advance the valve to the next cycle position: ie BRINE, Screen will display:



The valve will advance to the remainder of the regeneration cycle (RINSE and FULL) as per the above steps.

CalSoft Mini, Midi & Maxi

3. Installation - pipework



Typical Pipework Installation for the CalSoft

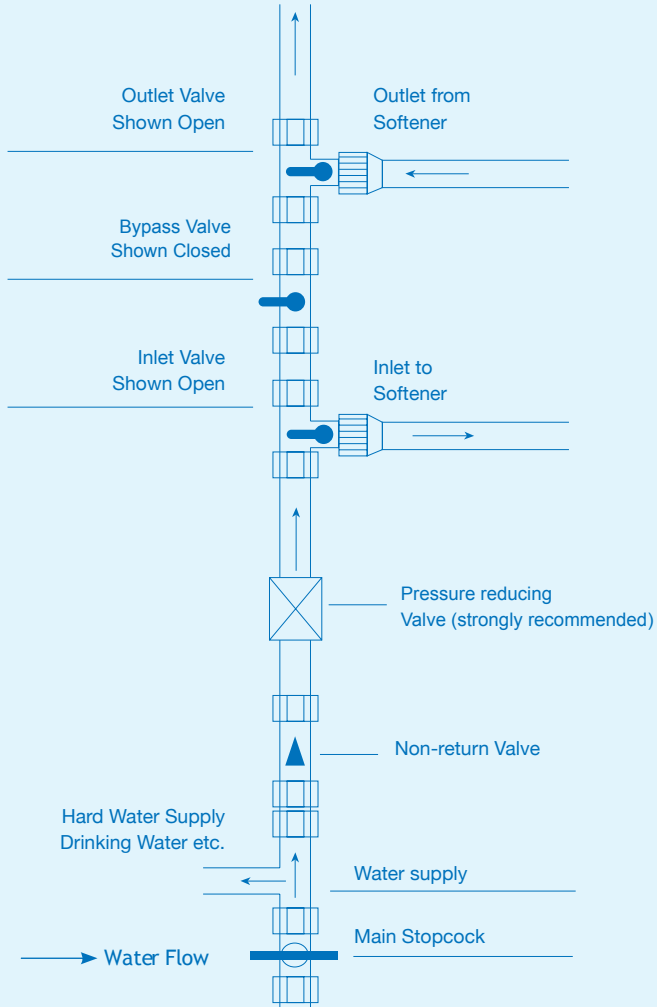

CalSoft Mini, Midi & Maxi

4. Dimensions

Dimensions

| | CALSOFT MINI | CALSOFT MIDI | CALSOFT MAXI |
|----------|--------------|--------------|--------------|
| A | 470mm | 470mm | 470mm |
| B | 660mm | 900mm | 1100mm |
| C | 330mm | 330mm | 330mm |

Please note

these dimensions are approximations and should be checked depending where the installation will be carried out i.e. in a confined area. Dimensions do not include pipework dimensions.

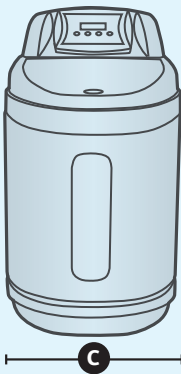
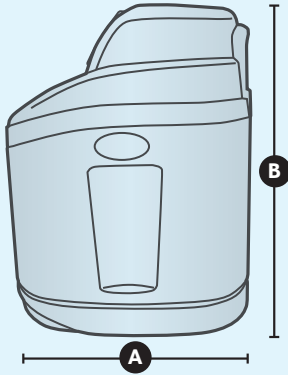

Installation and start up procedure

1. Turn off the mains water supply to the house by closing the stopcock. Then drain the pipe by opening the kitchen tap.
2. Cut the pipe after the stopcock and install the inlet, outlet and bypass valves. To comply with regulations a check valve must be installed between the stopcock and the softener.
3. Connect a hose between the softener inlet and the inlet valve, then connect a hose between the softener outlet and the outlet valve.
4. Turn off the inlet, outlet and bypass valves.
5. The drinking water tap connection and the garden tap connection should be made in the pipe between the stopcock and the bypass valve.
6. Run the drain tube to the nearest waste pipe, typically a washing machine type standpipe. Cut off any excess tube. Secure the pipe so that it cannot fall out of the standpipe. Ensure that it is installed with an air gap of 20mm.
7. Push the overflow hose onto the overflow connection on the back of the cabinet and run it downhill to the outside of the house, keep the hose as short as possible.
8. Turn red bypass handles to “In service” position as shown in page 11.
9. Open the mains stopcock then the inlet, outlet and bypass valves. Open the kitchen sink tap for a few minutes to remove all the air and any colour from the water, and then close the tap. Leave for 10 minutes, checking for leaks. Close bypass valve.
10. Plug the valve into an approved power source. Once powered, it is possible that the valve drives itself to the service position.
11. Set the time of day using the “PROGRAMMING” section of the manual.
12. Fill approximately 7 litres of water above the bottom of the salt bucket.
13. Start a manual regeneration using the “PROGRAMMING” section of the manual:

This will begin the regeneration cycle and allows the CalSoft to determine the correct water level in the cabinet. This process will take approximately 35 minutes.
14. After the regeneration cycle has completed salt can be added into the salt bucket at the front of the cabinet. The amount of salt is not critical apart from that there should always be 3-4kg in the bucket to accommodate at least one regeneration.

CalSoft Mini, Midi & Maxi

5. Installation guidelines

For the installer - Typical Installation

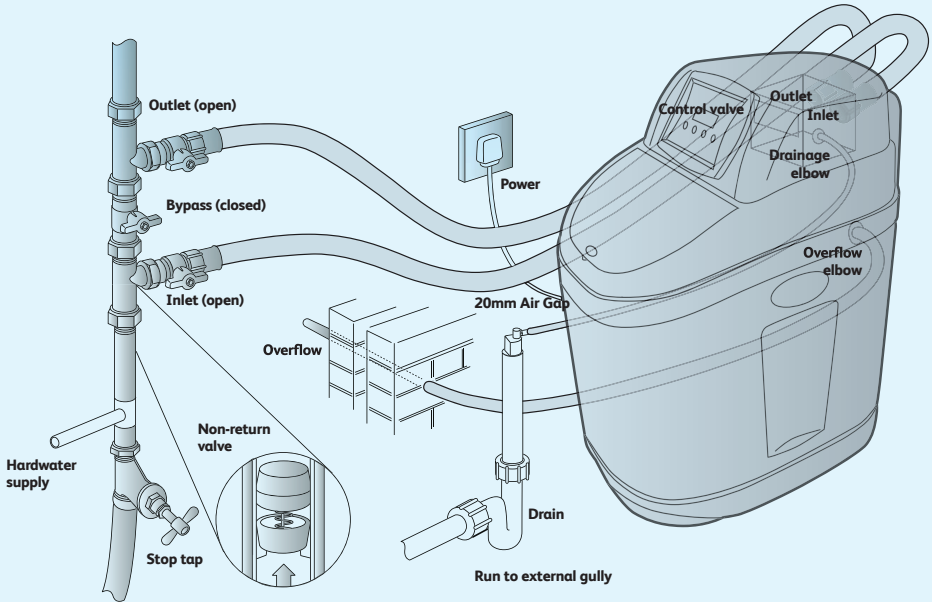

For further information please refer to the WRAS information and guidance note:
No 9-07-01 titled:

Information for installation of Ion Exchange Softeners for Systems Supplying Water
for Domestic Purposes.

(www.wras.co.uk)

Bypass Assembly

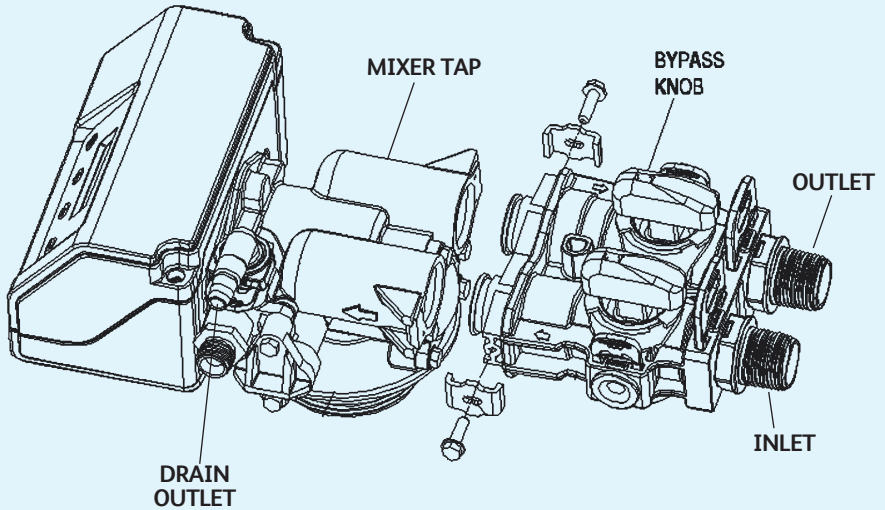

The bypass valve is provided with various functions such as bypass and water hardness adjustment.

Different angles of bypass knob have different functions (see below). The larger angle (value A), the higher water hardness in hardness adjustment position.

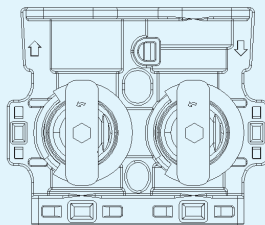

In-Service Position

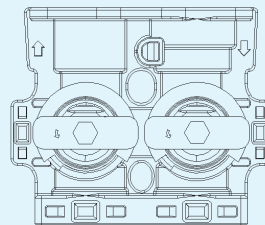

Bypass Position

CalSoft Mini, Midi & Maxi

6. Programming

Programming

1. Key Definition:

Menu key '☐':

- Press this key to enter or exit the menu.
- Press and hold this key for 3 seconds to unlock keys locked at standby status.

Set/Regen. key '■':

- Press this key to select a program or to save the settings.
- Press and hold the key for 3 seconds to initiate a manual regeneration at standby status.

Up and Down key '▲', '▼':

- Press the key to increase or decrease the value of the settings.
- Press the key to enter the previous or the next menu.

2. Setting Methods:

- Press the key '☐' to enter the menu.
- Press the key '▲' or '▼' to select a parameter.
- Press the key '■', the parameter starts flashing.
- Press the key '▲' or '▼' to change the value.
- Press the key '■' to save the setting.
- Press the key '▲' or '▼' to select other parameters.
- Follow the above steps to change other parameters.
- Press the key '☐' to exit settings.

You can only change the flashing parameters.

Program will be back to standby status if any key was not operated within 1 minute.
Without being operated within 3 minutes, the keys will be locked.

Notes



A large rectangular area with rounded corners, outlined in blue, containing 20 horizontal blue lines for writing notes.

CalSoft Mini, Midi & Maxi

7. Further Information

Troubleshooting

| SYMPTOM | PROBABLE CAUSE | CORRECTION |
|--|--|--|
| 1. Softener fails to regenerate automatically | <ul style="list-style-type: none"> A. Cord plugged into intermittent or dead power source. B. Disconnected meter cable. C. Defective power cord. D. Defective timer, meter or sensor. | <ul style="list-style-type: none"> A. Connect to constant power source. B. Reconnect cable. C. Replace cord. D. Replace or Repair. |
| 2. Regenerating at wrong time | <ul style="list-style-type: none"> A. Timer improperly set, due to Power failure. | <ul style="list-style-type: none"> A. Reset timer. |
| 3. Loss of capacity | <ul style="list-style-type: none"> A. Increased raw water hardness. B. Brine concentration and/or quality. C. Resin fouling. D. Poor distribution, Channeling (uneven bed surface). E. Internal valve leak. F. Resin age. G. Resin loss. | <ul style="list-style-type: none"> A. Reset unit to the new hardness capacity. B. Keep brine tank full of salt at all times. Clean it yearly. Salt may be bridged. If using a salt grid plate ensure refill water is over it. C. Call Calmag. Find out how to confirm it, clean the resin and prevent future fouling. D. Call Calmag. Check distributors and backwash flow. E. Call Calmag. Replace spacers, seals and/or piston. F. Call Calmag. Check for resin oxidation caused by chlorine. Mushy resin. G. Call Calmag. Check for correct bed depth. Broken distributors. Air or gas in bed: Well gas eliminator. Loose brine line. H. Close bypass valve. I. Check for too slow or high service flow. Check for media fouling. |
| 4. Poor water quality | <ul style="list-style-type: none"> A. Check items listed in *3 B. Bypass valve open. C. Channeling. | <ul style="list-style-type: none"> A. Adjust salt setting. B. See symptom No.7 |

Troubleshooting

| SYMPTOM | PROBABLE CAUSE | CORRECTION |
|---|--|---|
| 5. High salt usage | <p>A. High salt setting.</p> <p>B. Excessive water in brine tank.</p> | <p>A. Clean or replace pipeline. Pre-treat to prevent.</p> <p>B. Clean the resin. Pretreat to prevent</p> <p>C. Too many resin fines and/or sediment. Call Calmag, reset backwash flow rate, and/or adjust time.</p> |
| 6. Loss of water pressure | <p>A. Scaling/Fouling of inlet pipe.</p> <p>B. Fouled resin</p> <p>C. Improper backwash</p> | <p>A. Clean or replace pipeline.</p> <p>B. Clean the resin. Pre-treat to prevent.</p> <p>C. Too many resin fines and/or sediment. Call Calmag, reset backwash flow rate and/or adjust time.</p> |
| 7. Excessive water in brine tank and/or salty water to service | <p>A. Plugged drain line.</p> <p>B. Dirty or damaged brine valve.</p> <p>C. Plugged injector.</p> <p>D. Low inlet pressure.</p> <p>E. Timer not cycling.</p> <p>F. High water pressure.</p> | <p>A. Check flow to drain. Clean flow control.</p> <p>B. Clean or replace brine valve.</p> <p>C. Clean injector and replace screen.</p> <p>D. Increase pressure to allow injector to perform properly (1.5 bar minimum)</p> <p>E. Replace timer.</p> <p>F. Install a pressure reducing valve.</p> |
| 8. Softener fails to use salt | <p>A. Plugged/restricted drain line.</p> <p>B. Injector is plugged.</p> <p>C. No water in brine tank.</p> <p>D. Water pressure too low/high</p> <p>E. Brine line injects air during brine draw.</p> <p>F. Internal control leak.</p> | <p>A. Clean drain line and/or flow control.</p> <p>B. Clean or replace injector and screen.</p> <p>C. Check for restriction in BLFC. Ensure safety float is not struck. D. Line pressure must be at least 1.5 bar / 5 bar max.</p> <p>E. Check brine for air leaks.</p> |
| 9. Control cycles continuously | <p>A. Faulty timer.</p> | <p>A. Replace timer.</p> |
| 10. Continuous flow to drain | <p>A. Foreign material in control.</p> <p>B. Internal control leak.</p> <p>C. Valve jammed in brine or backwash position</p> <p>D. Timer motor stopped or jammed.</p> | <p>A. Call Calmag. Clean valve, rebuild unit.</p> <p>B. Same as above.</p> <p>C. Same as above.</p> <p>D. Replace timer motor.</p> |

If any of the above occur please contact Calmag prior to any work being undertaken otherwise any guarantees may become invalid.

CalSoft Mini, Midi & Maxi

7. Further Information

Advice from various international bodies state that when a water softener has been installed then a separate unsoftened water tap should be provided - mainly for drinking water purposes. This would normally be at the kitchen sink as this would ordinarily be the main area that people would pour drinking water from and also used for cooking purposes. Alternative positions for this supply, or more than one supply can be installed, and is purely down to the individual application. The separate unsoftened drinking tap should then be connected into the supply pipe prior to the bypass valve and then run directly to the specified drinking tap. See illustration below.

The Regulations state that “All premises supplied with water for domestic purposes shall have at least one tap conveniently situated for the drawing of drinking water”. Drinking water must also comply with the Regulations which stipulate a maximum limit of 200ppm for sodium. The Department of Health recommends that this sodium level should not be exceeded for baby food preparation and also for individuals that may be on a low sodium diet.

As the maximum limit is set at 200ppm, it is therefore necessary to check if this would be exceeded in the area and could be the case where the water is extremely hard. This level of sodium would be exceeded if the incoming water hardness reaches 425ppm (assuming that the incoming level of sodium is zero from the mains supply). This can be checked with the Calmag water hardness test kit or alternatively by asking the local water supplier the level of hardness and sodium in the area. Once this information is confirmed then a balanced decision can be made for the requirements of a water filter or not.

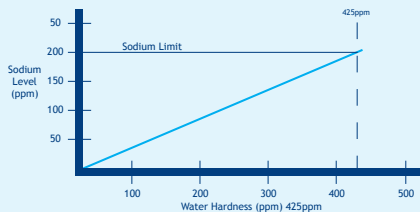

Typical Installations

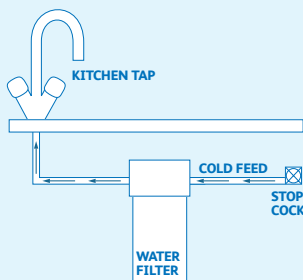
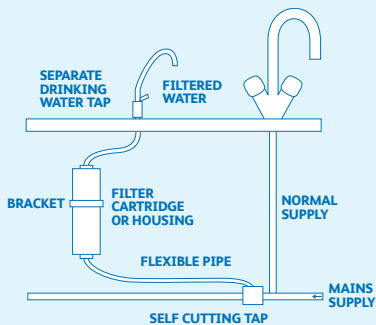

Replacement filters...

Contaminants are trapped within the filter cartridge, therefore you need to change them on a regular basis to maintain a clean water supply.

The lifespan of a cartridge is dependent on the quality of water passing through it and we recommend changing filter cartridges every 4-6 months.



CALSLIM C KIT



CALFRESH CR KIT

CalSoft Mini, Midi & Maxi

8. Limited Warranty Statement

Products manufactured by CALMAG are warranted to the original user only to be free of defects in material and workmanship for a period as specified below. This warranty only applies to the original purchaser and is not transferable.

CalSoft unit - parts only

Five (5) year Limited Warranty on the unit, from the date of original purchase, or installation (documentation required for verification).

CalSoft unit - labour only

One (1) year Limited Warranty on the unit for labour, from the date of original purchase, or installation (documentation required for verification).

CALMAG warrants that it will repair or replace, at CALMAG's discretion, any unit or component that is defective in materials or workmanship for the period as outlined above, subject to the "Limitations of Warranty" as outlined below. CALMAG's liability under this warranty shall be limited to repairing or replacing at CALMAG's discretion, without charge, any product that CALMAG manufactures. CALMAG will not be liable for any costs of removal, installation, transportation, or any other charges which may arise in connection with a warranty claim. Products which are sold but not manufactured by CALMAG are subject to the warranty provided by the manufacturer of said products and not by CALMAG's warranty. CALMAG will not be liable for damage or wear to products caused by abnormal operating conditions, accident, abuse, misuse, unauthorised alteration or repair, or if the product was not installed in accordance with CALMAG's printed installation and operating instructions.

Limitations of Warranty

This warranty does not apply to any of the following:

- A product that has been incorrectly installed according to the technical installation manual.
- A product that has been modified in any manner, unless approved by the manufacturer.
- A product where the serial number has been altered, defaced or removed.
- Damage caused by the use of parts that are not compatible, suitable and/or authorised by CALMAG for use with the product.
- Damage caused during shipment of the product.
- Water damage is found inside the valve electronics.
- Product is installed outdoors in direct contact with the environment (ie, rain).
- Product is installed in freezing temperatures.
- Product is used in conditions that exceed CALMAG specifications.

CalSoft Mini, Midi & Maxi

8. Limited Warranty Statement



To obtain warranty service

To obtain service under this warranty, you must first contact CALMAG's Customer Service at 01535 210 320 to obtain a Goods Return Number and authorisation. You will need to return the product through the outlet where the product was originally purchased, together with proof of purchase and installation date, failure date, and supporting installation data. Unless otherwise provided, the merchant will contact CALMAG for instructions on returning the product. Any defective product to be returned to CALMAG must be sent carriage prepaid; documentation supporting the warranty claim and/or a Goods Return Number must be included if so instructed.

CALMAG WILL NOT BE LIABLE FOR ANY INCIDENTAL OR CONSEQUENTIAL DAMAGES, LOSSES, OR EXPENSES ARISING FROM INSTALLATION, USE, OR ANY OTHER CAUSES. THERE ARE NO EXPRESS OR IMPLIED WARRANTIES, INCLUDING MERCHANTABILITY OR FITNESS FOR A PARTICULAR PURPOSE, WHICH EXTEND BEYOND THOSE WARRANTIES DESCRIBED OR REFERRED TO ABOVE.

THIS LIMITED WARRANTY IS THE SOLE AND EXCLUSIVE WARRANTY MADE BY CALMAG WITH RESPECT TO THE PRODUCT, AND IS GIVEN IN LIEU OF ANY OTHER WARRANTY. TO THE EXTENT ALLOWED BY APPLICABLE LAW, ANY AND ALL EXPRESS OR IMPLIED WARRANTIES NOT SET FORTH HEREIN ARE WAIVED AND DISCLAIMED, INCLUDING ANY IMPLIED WARRANTY OF MERCHANTABILITY OR FITNESS FOR A PARTICULAR USE. CALMAG'S LIABILITY UNDER THIS LIMITED WARRANTY IS LIMITED SOLELY TO THOSE LIABILITIES SET FORTH ABOVE. IN THE EVENT THAT ANY PROVISION OF THIS LIMITED WARRANTY SHOULD BE OR BECOME INVALID OR UNENFORCEABLE UNDER APPLICABLE LAW, THE REMAINING TERMS AND CONDITIONS HEREOF SHALL REMAIN IN FULL FORCE AND EFFECT AND SUCH INVALID OR UNENFORCEABLE PROVISION SHALL BE CONSTRUED IN SUCH A MANNER AS TO BE VALID AND ENFORCEABLE.

Program Settings

| MINI | MIDI | MAXI |
|--------------------------------|--------------------------------|--------------------------------|
| LANGUAGE ENG | LANGUAGE ENG | LANGUAGE ENG |
| METRIC | METRIC | METRIC |
| MET IMMEDIATE | MET IMMEDIATE | MET IMMEDIATE |
| DATE | DATE | DATE |
| TIME | TIME | TIME |
| REG CAP 02.00 (2000 LITRES) | REG CAP 03.00 (3000 LITRES) | REG CAP 04.00 (4000 LITRES) |
| BW 5 | 10 | 15 |
| BRI 45 | 35 | 50 |
| RR 04 | 08 | 10 |
| FILL 5.5 | 5.0 | 7.0 |
| L / M / [S] | L / [M] / S | [L] / M / S |

NOTE: Settings are based on a typical household in a hard water area and should not require any adjustments. Please call Calmag prior to any hardness adjustment on 01535 210 320 and press option 2.



Mini, Midi and Maxi



Telephone: 01535 210320

Fax: 01535 210321

Email: sales@calmagltd.com

Website: www.calmagltd.com



Rev 05.16